

4SR

4" submersible pumps



PERFORMANCE RANGE

- Flow rate up to **375 l/min** (22.5 m³/h)
- Head up to **405 m**

APPLICATION LIMITS

- Maximum liquid temperature **+35 °C**
- Maximum sand content **150 g/m³**
- **100 m** immersion limit
- Installation:
 - vertical
 - horizontal, with the following limits:
 - 4SR1 - 4SR1.5 - 4SR2 - 4SR4 up to **27 stages**
 - 4SR6 - 4SR8 - 4SR10 - 4SR12 - 4SR15 up to **17 stages**
- Starts/hour: 20 at regular intervals
- Minimum flow rate for motor cooling **8 cm/s**
- Continuous service **S1**

CONSTRUCTION AND SAFETY STANDARDS

ELECTRIC MOTOR

- Single-phase 230 V - 50 Hz
- Three-phase 400 V - 50 Hz

Length of power cable:

- **1.5 m** for powers from 0.37 to 3 kW
- **2.5 m** for powers from 4 to 5.5 kW (7.5 kW 4SR-FK)
- **3.5 m** for power from 7.5 kW 4SR-PD

⇒ The **4SR-PD** single-phase versions come with a capacitor included in the packaging.

EN 60335-1
IEC 60335-1
CEI 61-150

EN 60034-1
IEC 60034-1
CEI 2-3



CERTIFICATIONS



AM30



УкрТЕСТ - 003

INSTALLATION AND USE

Suitable for use with clean water with a sand content of no more than **150 g/m³**. As a result of their high efficiency and reliability, they are suitable for use in domestic, civil and industrial applications such as for the distribution of water in combination with pressure sets, for irrigation, for washing plants and for pressure boosting in fire-fighting sets, etc.

PATENTS - TRADE MARKS - MODELS

- Patent Pending n° PCT/EP2009/059855 (cable cover)
- Patent Pending n° PCT/IB2009/051491 (for single-phase 4SR-PD up to 0.75 kW; three-phase up to 1.1 kW).

OPTIONALS AVAILABLE ON REQUEST

- Other voltages or 60 Hz frequency

GUARANTEE

2 years subject to terms and conditions

PERFORMANCE RANGE

50 Hz n= 2900 1/min

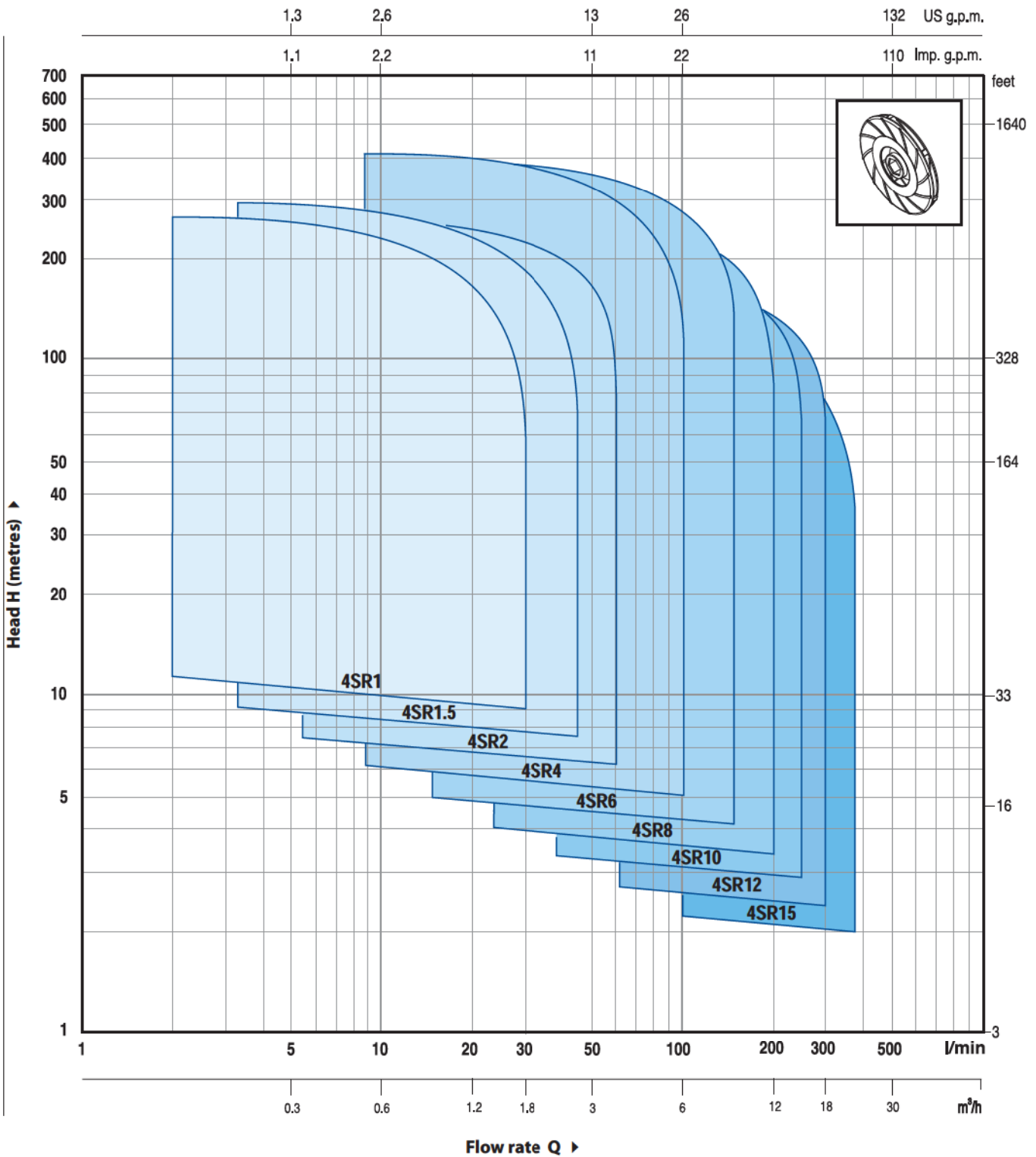

DESCRIPTION

4 SR 1 m / 13 - PD or FK or HYD

- Borehole diameter in inches _____
- Series _____
- Flow rate in m³/h at the point of highest efficiency _____
- Single-phase motor _____
- Number of stages _____
- PD:** pump with "PEDROLLO" motor _____
- FK:** pump with "FRANKLIN" motor _____
- HYD:** pump without motor _____

CHARACTERISTIC CURVES AND PERFORMANCE DATA

50 Hz n= 2900 1/min

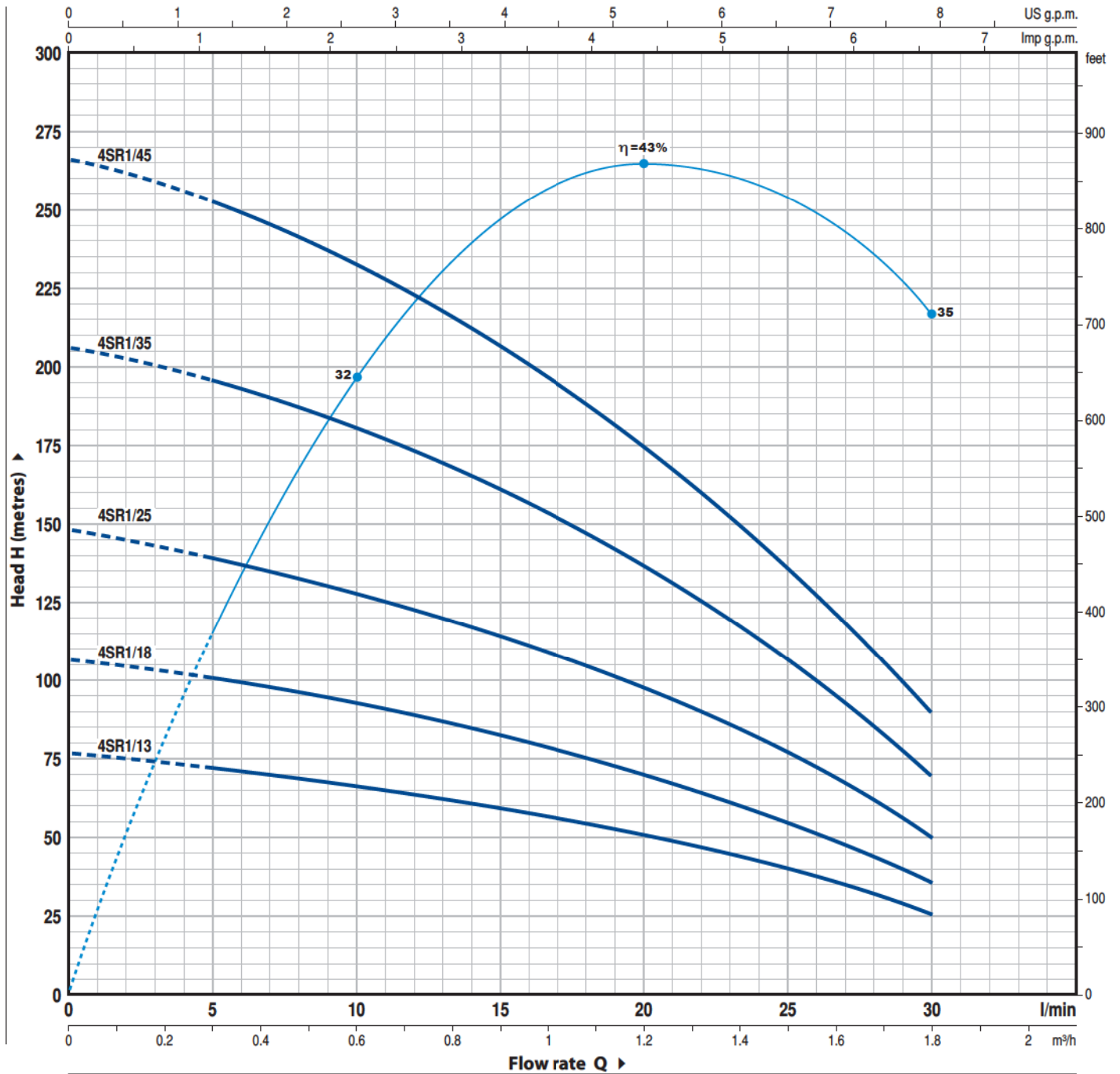

MODEL		POWER		Q	Flow rate (l/min)						
Single-phase	Three-phase	kW	HP		0	0.3	0.6	0.9	1.2	1.5	1.8
4SR1m/13	4SR1/13	0.37	0.50	H metres	77	73	67	60	51	40	26
4SR1m/18	4SR1/18	0.55	0.75		107	101	93	83	71	55	36
4SR1m/25	4SR1/25	0.75	1		148	140	129	115	98	77	50
4SR1m/35	4SR1/35	1.1	1.5		206	197	182	161	136	107	70
4SR1m/45	4SR1/45	1.5	2		266	254	234	207	176	137	90

Q = Flow rate H = Total manometric head

Tolerance of characteristic curves in compliance with EN ISO 9906 App. A.

CHARACTERISTIC CURVES AND PERFORMANCE DATA

50 Hz n= 2900 1/min

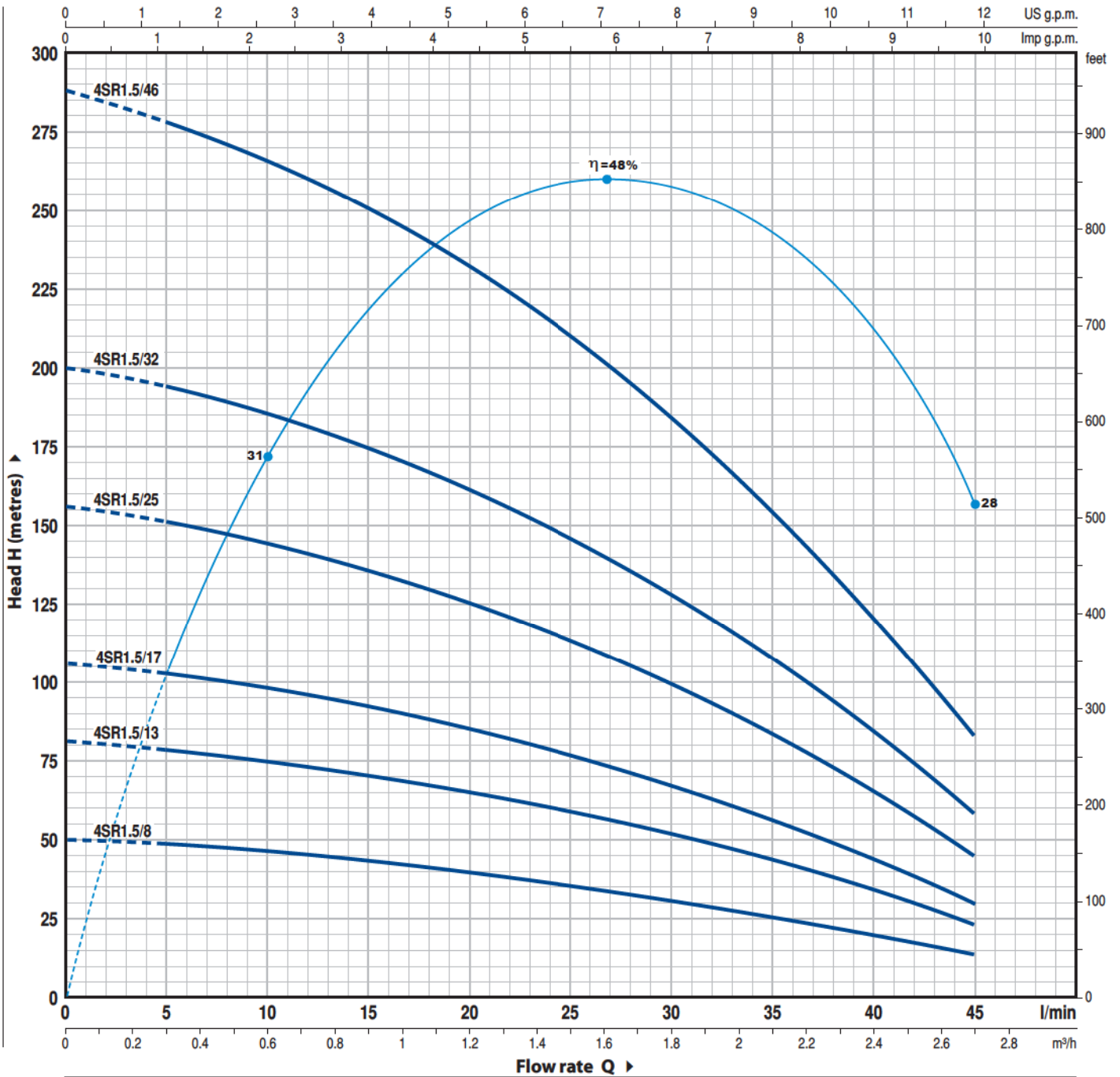

MODEL		POWER		Q	Flowrate (l/min)														
Single-phase	Three-phase	kW	HP		0	5	10	15	20	25	30	35	40	45					
4SR1.5m/8	4SR1.5/8	0.37	0.50	H metres	50	48	46	44	40	36	32	26	20	14					
4SR1.5m/13	4SR1.5/13	0.55	0.75		81	78	75	71	66	59	52	43	33	23					
4SR1.5m/17	4SR1.5/17	0.75	1		106	102	98	93	86	78	68	56	43	30					
4SR1.5m/25	4SR1.5/25	1.1	1.5		156	151	144	136	127	115	100	83	64	45					
4SR1.5m/32	4SR1.5/32	1.5	2		200	193	184	175	162	147	128	106	82	58					
4SR1.5m/46	4SR1.5/46	2.2	3		288	277	265	250	233	211	184	153	117	83					

Q = Flow rate H = Total manometric head

Tolerance of characteristic curves in compliance with EN ISO 9906 App. A.

CHARACTERISTIC CURVES AND PERFORMANCE DATA

50 Hz n= 2900 1/min

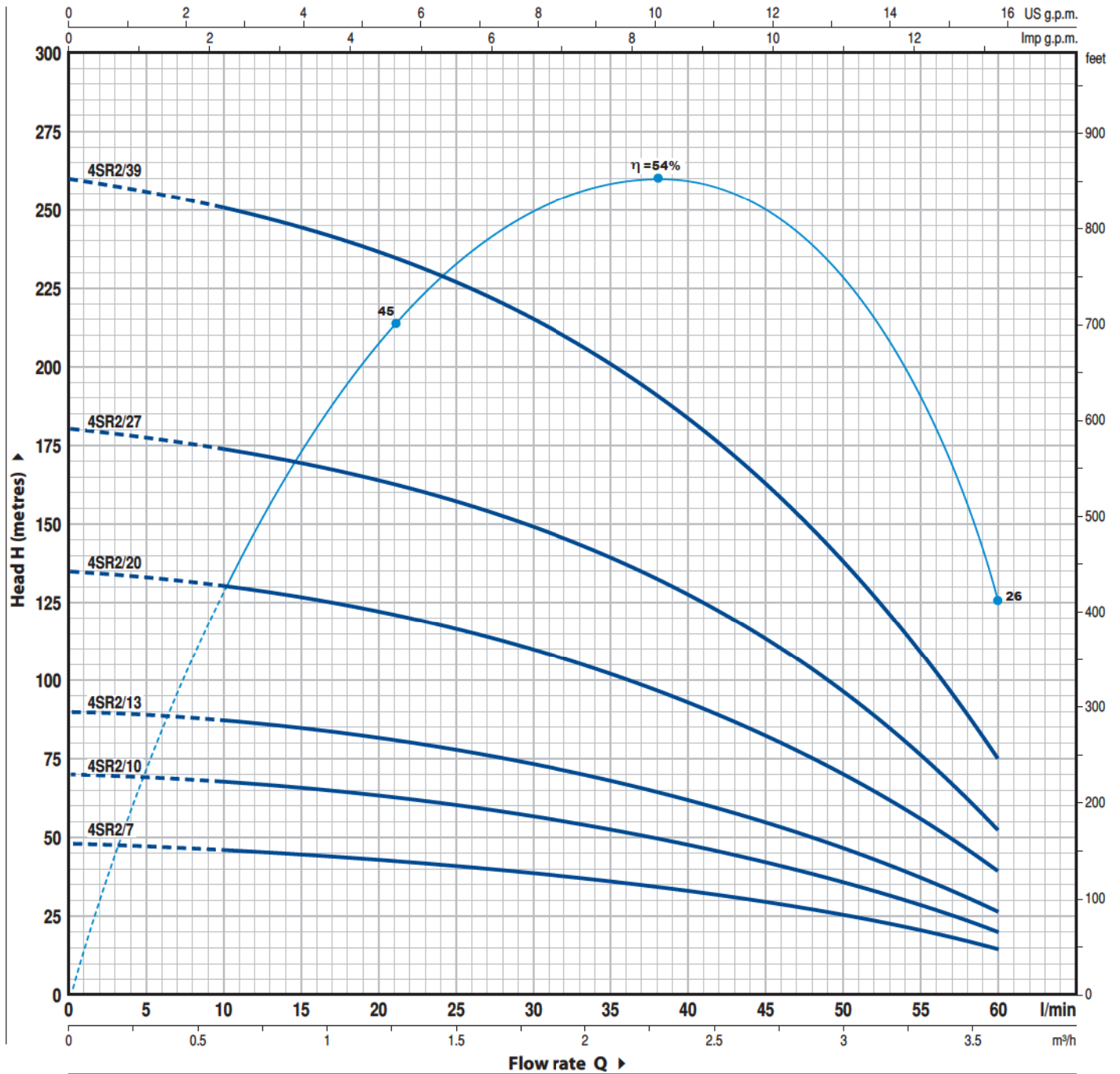

MODEL		POWER		Q	0	0.6	1.2	1.8	2.4	3.0	3.6
Single-phase	Three-phase	kW	HP								
4SR2m/7	4SR2/7	0.37	0.50	H metres	0	10	20	30	40	50	60
4SR2m/10	4SR2/10	0.55	0.75		48	46	44	39	33	25	14
4SR2m/13	4SR2/13	0.75	1		70	68	63	57	48	36	20
4SR2m/20	4SR2/20	1.1	1.5		90	88	82	74	62	46	26
4SR2m/27	4SR2/27	1.5	2		135	130	122	111	93	71	39
4SR2m/27	4SR2/27	1.5	2		180	173	164	150	126	96	52
4SR2m/39	4SR2/39	2.2	3		260	250	238	216	183	138	75

Q = Flow rate H = Total manometric head

Tolerance of characteristic curves in compliance with EN ISO 9906 App. A.

CHARACTERISTIC CURVES AND PERFORMANCE DATA

50 Hz n= 2900 1/min

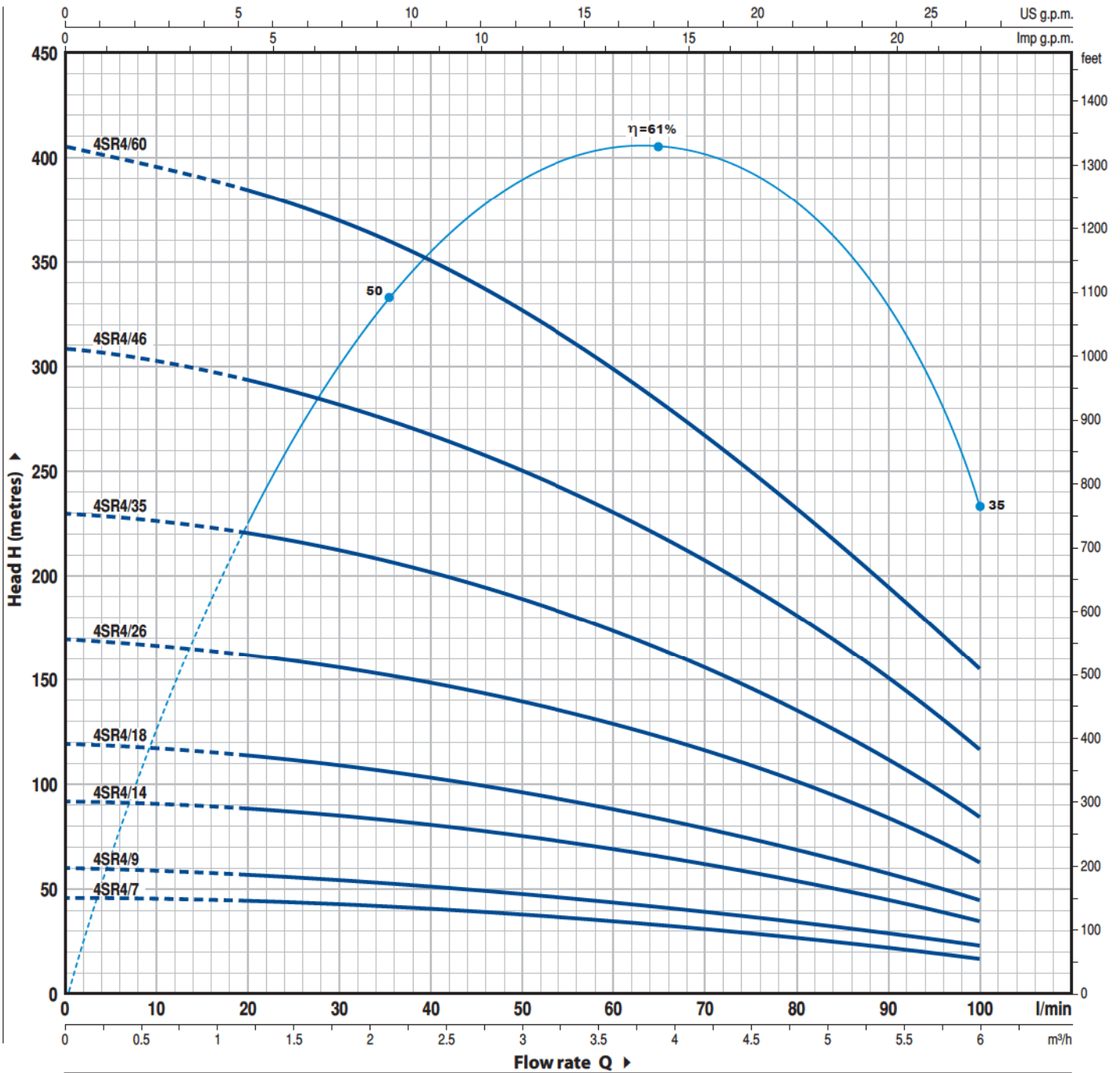

MODEL		POWER		Q	H metres													
Single-phase	Three-phase	kW	HP		m³/h	0	1.2	1.8	2.4	3.0	3.6	4.2	4.8	5.4	6.0			
				l/min	0	20	30	40	50	60	70	80	90	100				
4SR4m/7	4SR4/7	0.55	0.75		46	44	42	40	38	35	32	28	23	17				
4SR4m/9	4SR4/9	0.75	1		60	56	55	52	49	45	40	35	29	23				
4SR4m/14	4SR4/14	1.1	1.5		92	88	85	81	76	70	63	55	45	35				
4SR4m/18	4SR4/18	1.5	2		120	112	109	104	98	90	81	70	58	45				
4SR4m/26	4SR4/26	2.2	3		170	162	157	150	141	130	116	101	84	63				
-	4SR4/35	3	4		230	220	211	202	190	175	157	137	113	85				
-	4SR4/46	4	5.5		308	293	280	269	249	230	205	181	151	117				
-	4SR4/60	5.5	7.5		405	385	370	350	325	300	270	235	195	155				

Q = Flow rate H = Total manometric head

Tolerance of characteristic curves in compliance with EN ISO 9906 App. A.

4SR6

CHARACTERISTIC CURVES AND PERFORMANCE DATA

50 Hz n= 2900 1/min

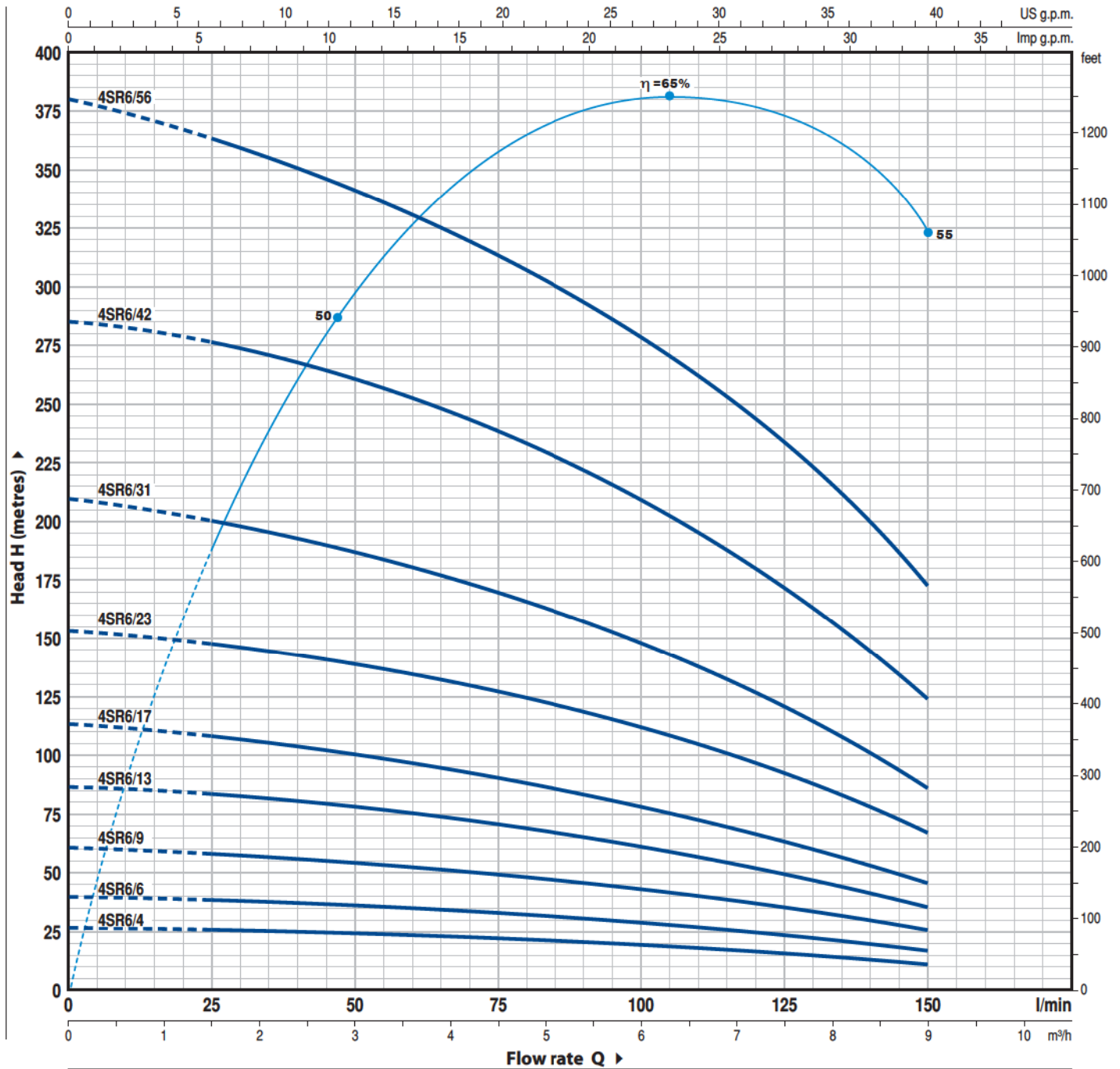

MODEL		POWER		Q	H metres						
Single-phase	Three-phase	kW	HP		0	1.5	3.0	4.5	6.0	7.5	9.0
4SR6m/4	4SR6/4	0.55	0.75	0	0	25	50	75	100	125	150
4SR6m/6	4SR6/6	0.75	1	1	27	26	24	22	19	15	11
4SR6m/9	4SR6/9	1.1	1.5	2	40	38	36	33	29	24	17
4SR6m/13	4SR6/13	1.5	2	3	61	58	54	50	44	35	26
4SR6m/17	4SR6/17	2.2	3	4	87	83	78	71	61	49	35
-	4SR6/23	3	4	5	114	107	100	91	79	62	45
-	4SR6/31	4	5.5	6	154	148	138	128	112	92	67
-	4SR6/42	5.5	7.5	7	210	200	186	170	149	121	86
-	4SR6/56	7.5	10	8	285	276	258	240	212	170	124
-	-	-	-	9	380	365	340	315	280	233	173

Q = Flow rate H = Total manometric head

Tolerance of characteristic curves in compliance with EN ISO 9906 App. A.

CHARACTERISTIC CURVES AND PERFORMANCE DATA

50 Hz n= 2900 1/min

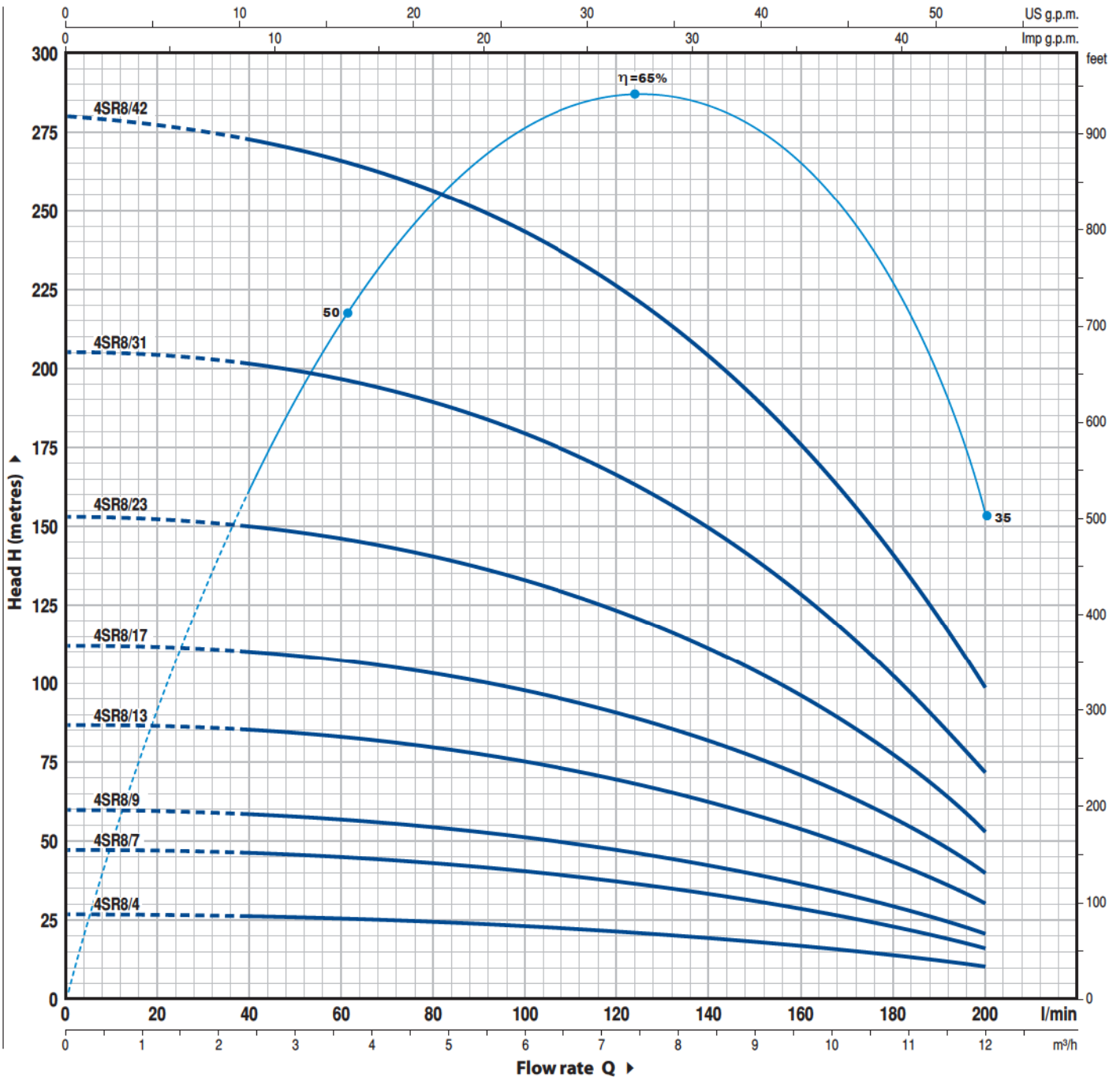

MODEL		POWER		Q	Flowrate (l/min)											
Single-phase	Three-phase	kW	HP		0	2.4	3.6	4.8	6.0	7.2	8.4	9.6	10.8	12.0		
4SR8m/4	4SR8/4	0.75	1	H metres	0	40	60	80	100	120	140	160	180	200		
4SR8m/7	4SR8/7	1.1	1.5		27	26	25	24	23	22	20	17	13	10		
4SR8m/9	4SR8/9	1.5	2		47	46	45	43	41	38	34	29	23	16		
4SR8m/13	4SR8/13	2.2	3		60	58	57	55	52	48	43	37	30	21		
-	4SR8/17	3	4		87	85	83	80	76	70	63	54	43	30		
-	4SR8/23	4	5.5		112	110	108	104	99	92	82	70	56	40		
-	4SR8/31	5.5	7.5		153	150	146	141	134	124	111	95	76	53		
-	4SR8/42	7.5	10		205	200	196	190	181	167	149	128	103	72		
					280	272	266	257	244	225	202	175	140	98		

Q = Flow rate H = Total manometric head

Tolerance of characteristic curves in compliance with EN ISO 9906 App. A.

4SR10

CHARACTERISTIC CURVES AND PERFORMANCE DATA

50 Hz n= 2900 1/min

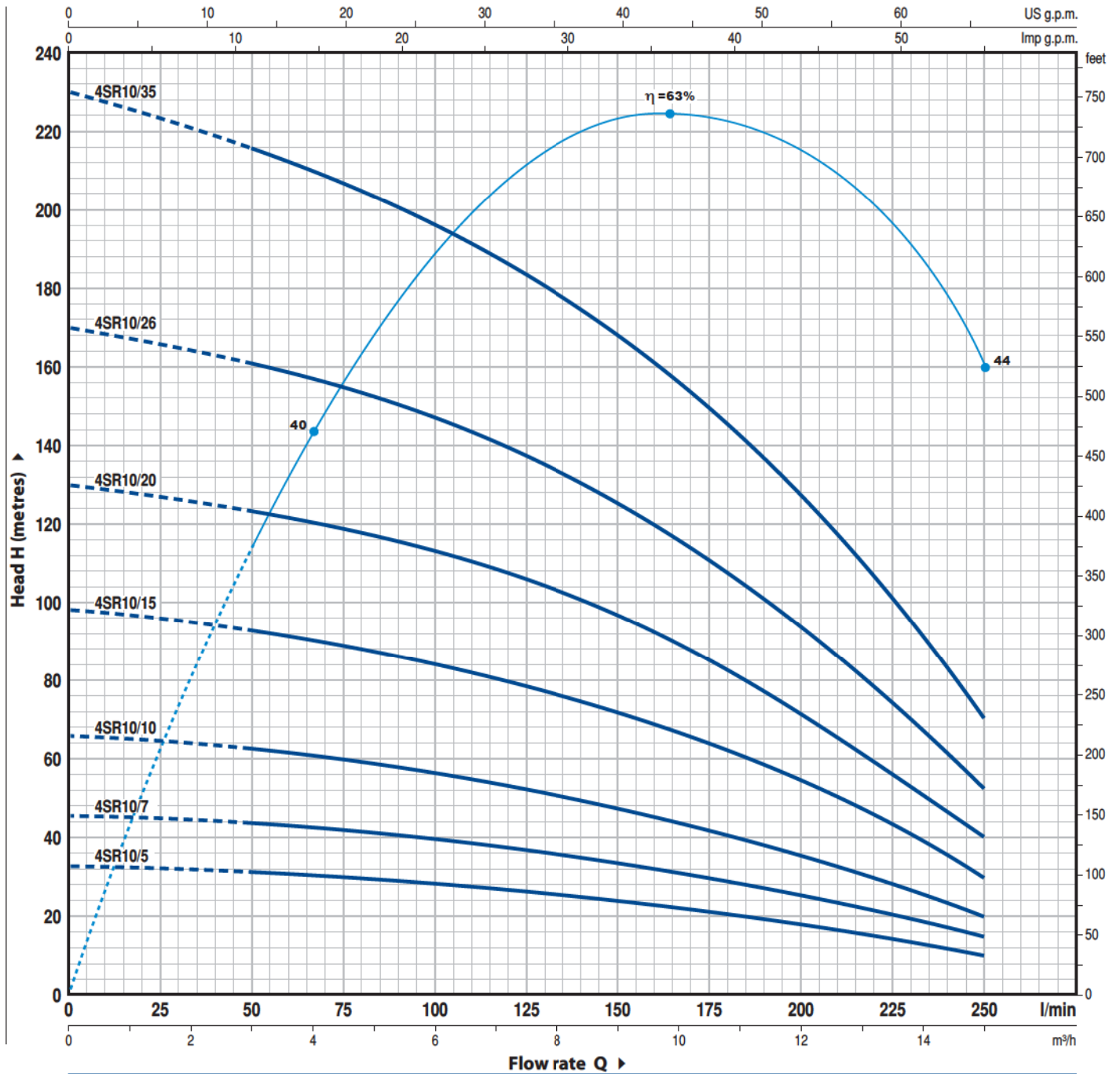

MODEL		POWER		Q	Flow rate (l/min)										
Single-phase	Three-phase	kW	HP		0	3.0	4.5	6.0	7.5	9.0	10.5	12	13.5	15.0	
4SR10m/5	4SR10/5	1.1	1.5	H metres	0	50	75	100	125	150	175	200	225	250	
4SR10m/7	4SR10/7	1.5	2		33	31	30	28	26	24	21	18	14	10	
4SR10m/10	4SR10/10	2.2	3		46	43	41	39	37	34	30	25	20	15	
-	4SR10/15	3	4		66	62	59	56	53	48	42	36	28	20	
-	4SR10/20	4	5.5		98	92	88	84	79	72	64	53	42	30	
-	4SR10/26	5.5	7.5		130	123	118	112	106	96	85	71	56	40	
-	4SR10/35	7.5	10		170	160	154	147	138	126	110	94	72	52	
					230	216	208	197	184	168	148	126	100	70	

Q = Flow rate H = Total manometric head

Tolerance of characteristic curves in compliance with EN ISO 9906 App. A.

CHARACTERISTIC CURVES AND PERFORMANCE DATA

50 Hz n= 2900 1/min

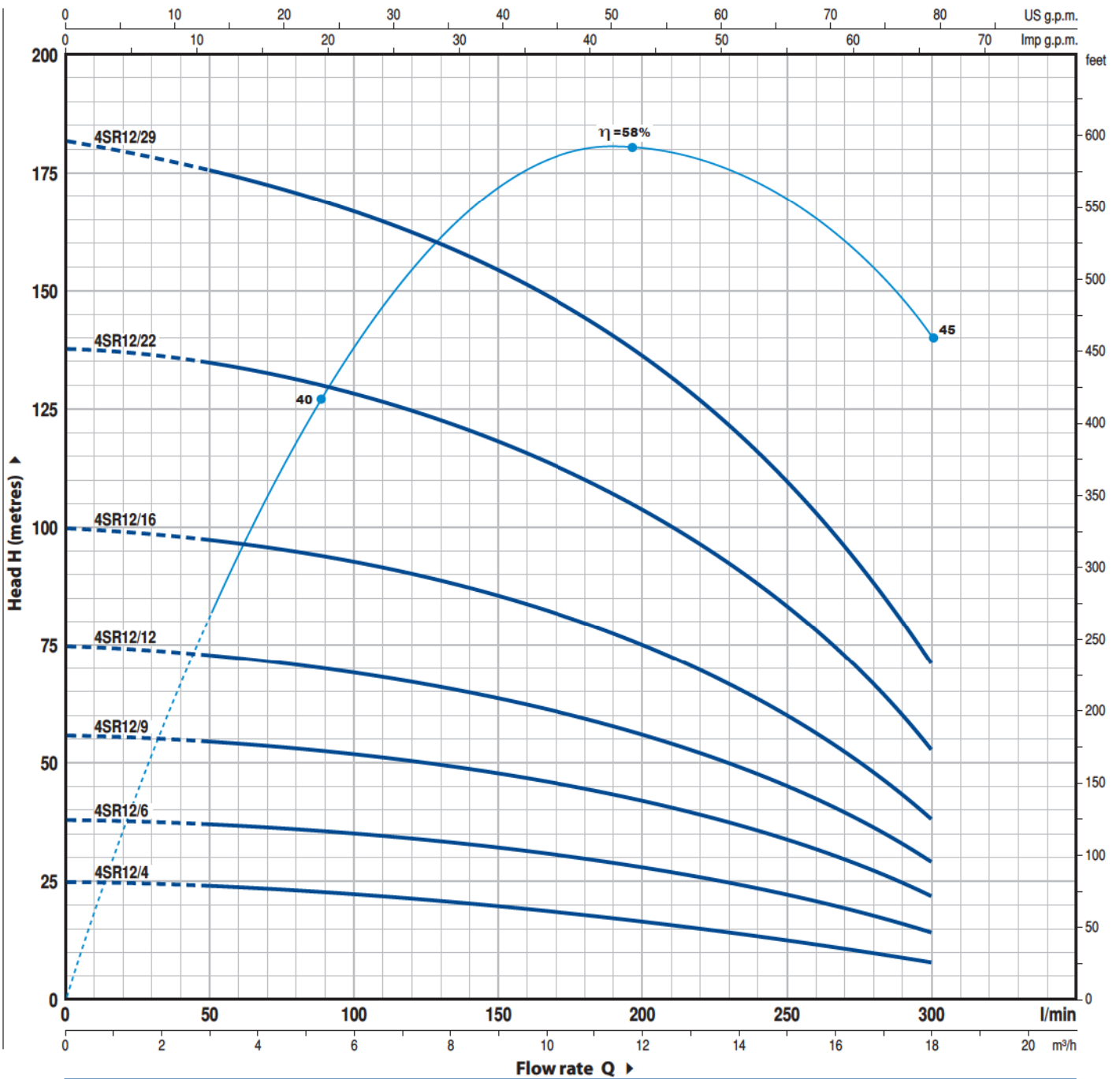

MODEL		POWER		Q	Flowrate (l/min)													
Single-phase	Three-phase	kW	HP		0	3.0	6.0	9.0	12.0	13.2	14.4	15.6	16.8	18.0				
4SR12m/4	4SR12/4	1.1	1.5	0	0	50	100	150	200	220	240	260	280	300				
				25	24	22	19	16	15	14	12	11	8					
				38	37	35	32	28	26	24	21	18	14					
				56	55	52	48	42	39	36	32	27	22					
				75	73	69	64	56	52	48	43	36	29					
				100	97	93	86	75	70	64	57	48	38					
				138	135	127	118	103	96	88	78	66	53					
				182	176	167	155	135	126	116	103	88	71					

Q = Flow rate H = Total manometric head

Tolerance of characteristic curves in compliance with EN ISO 9906 App. A.

4SR15

CHARACTERISTIC CURVES AND PERFORMANCE DATA

50 Hz n= 2900 1/min

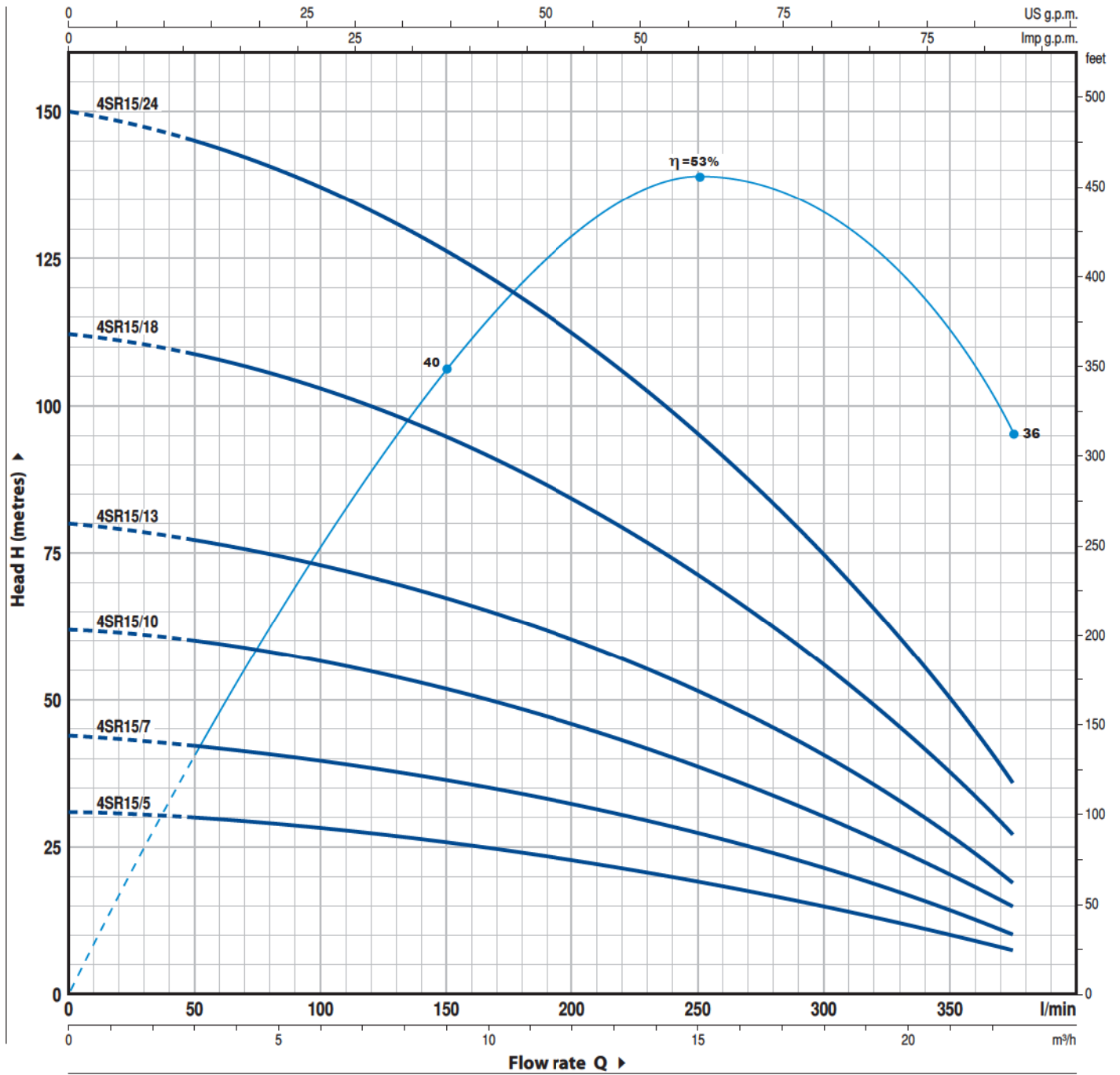

MODEL		POWER		Q	Flow rate												
Single-phase	Three-phase	kW	HP		m³/h	0	3.0	6.0	9.0	12.0	15.0	18.0	21.0	22.5			
				l/min	0	50	100	150	200	250	300	350	375				
4SR15m/5	4SR15/5	1.5	2	H metres	31	30	28	26	23	20	15	10	7.5				
4SR15m/7	4SR15/7	2.2	3		44	42	40	37	32	27	20	13	10				
-	4SR15/10	3	4		62	60	57	52	46	38	30	20	15				
-	4SR15/13	4	5.5		80	77	72	68	60	50	40	25	19				
-	4SR15/18	5.5	7.5		112	108	102	95	85	71	55	37	27				
-	4SR15/24	7.5	10		150	145	138	126	112	95	75	50	36				

Q = Flow rate H = Total manometric head

Tolerance of characteristic curves in compliance with EN ISO 9906 App. A.

POS.	DESCRIPTION	CONSTRUCTION CHARACTERISTICS
1	DELIVERY BODY	Precision cast stainless steel AISI 304, complete with threaded delivery port in compliance with ISO 228/1
2	NON-RETURN VALVE	Stainless steel AISI 304
3	MOTOR BRACKET	Stainless steel AISI 304, in compliance with NEMA standards
4	IMPELLER	Lexan 141-R
5	DIFFUSER	Noryl GFN2V
6	STAGE CASING	Stainless steel AISI 304
7	PUMP SHAFT	Stainless steel AISI 304
8	PUMP BEARINGS	Special-technopolymer housing with stainless steel AISI 316, chrome oxide coated, sand resistant shaft bushing
9	DRIVE COUPLING	Stainless steel AISI 316L up to 2.2 kW; stainless steel AISI 304 for higher powers
10	FILTER	Stainless steel AISI 304
11	CABLE COVER	Stainless steel AISI 304
12	MOTOR 4"	4PD = "PEDROLLO" 4FK = "FRANKLIN"

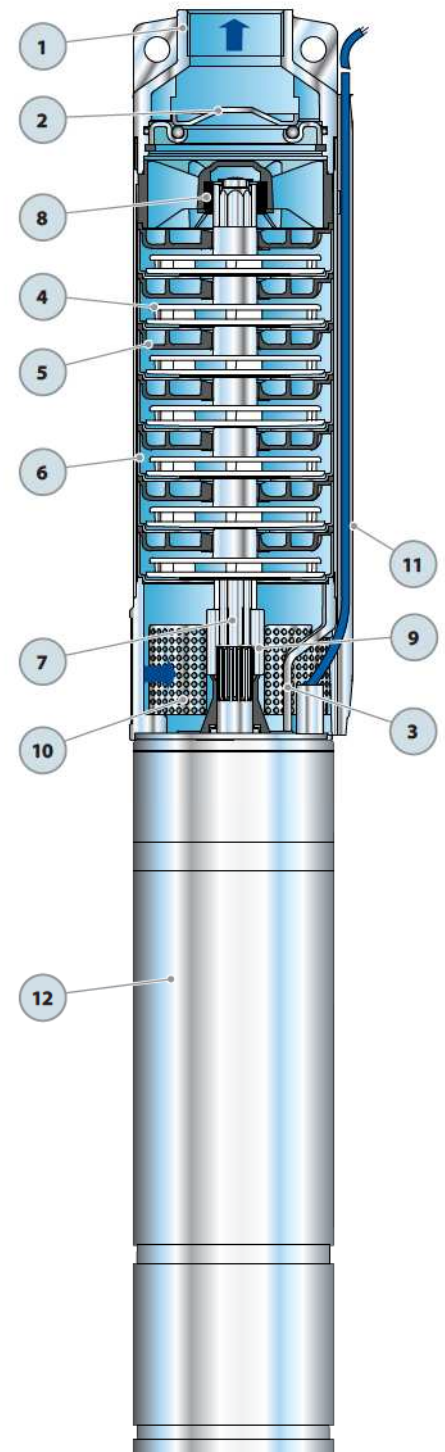

DIMENSIONS AND WEIGHT

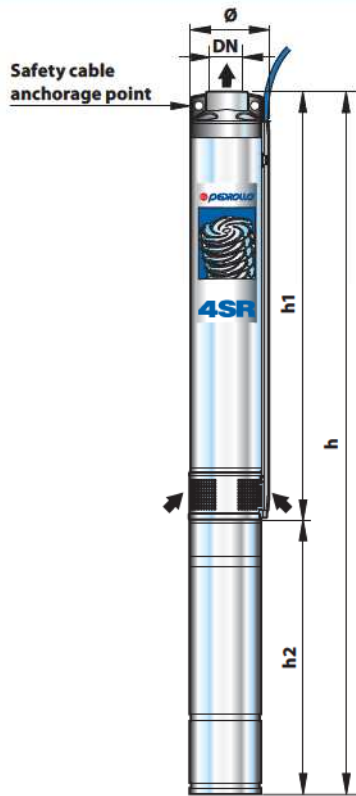

MODEL	PORT DN	DIMENSIONS mm			kg	
		Ø	h1	h2		h
Single-phase						
4SR1m/13 - PD	1 1/4"	98	400	304	704	11.8
4SR1m/18 - PD			517	329	846	14.5
4SR1m/25 - PD			646	354	1000	17.0
4SR1m/35 - PD			856	434	1290	21.6
4SR1m/45 - PD			1065	467	1532	25.5
4SR1.5m/8 - PD			308	304	612	10.9
4SR1.5m/13 - PD			400	329	729	14.5
4SR1.5m/17 - PD			499	354	853	15.5
4SR1.5m/25 - PD			646	434	1080	20.0
4SR1.5m/32 - PD			800	467	1267	24.3
4SR1.5m/46 - PD			1134	565	1699	31.9
4SR2m/7 - PD			290	304	594	10.7
4SR2m/10 - PD			345	329	674	12.5
4SR2m/13 - PD			400	354	754	14.4
4SR2m/20 - PD			554	434	988	18.3
4SR2m/27 - PD			683	467	1150	21.4
4SR2m/39 - PD	929	565	1494	29.2		
4SR4m/7 - PD	2"	98	314	329	643	12.1
4SR4m/9 - PD			358	354	712	13.7
4SR4m/14 - PD			468	434	902	17.2
4SR4m/18 - PD			580	467	1047	19.9
4SR4m/26 - PD			756	565	1321	25.5
4SR6m/4 - PD			281	329	610	12.8
4SR6m/6 - PD			341	354	695	13.4
4SR6m/9 - PD			431	434	865	16.6
4SR6m/13 - PD			576	467	1043	19.5
4SR6m/17 - PD			695	565	1260	25.5
4SR8m/4 - PD			281	354	635	12.8
4SR8m/7 - PD			371	434	805	16.1
4SR8m/9 - PD			431	467	898	18.2
4SR8m/13 - PD			576	565	1141	24.1
4SR10m/5 - PD			416	434	850	17.0
4SR10m/7 - PD			518	467	985	18.8
4SR10m/10 - PD	709	565	1274	25.0		
4SR12m/4 - PD	365	434	799	16.5		
4SR12m/6 - PD	467	467	934	17.7		
4SR12m/9 - PD	658	565	1223	25.0		
4SR15m/5 - PD	421	467	888	18.6		
4SR15m/7 - PD	525	565	1090	24.0		

MODEL	PORT DN	DIMENSIONS mm			kg			
		Ø	h1	h2		h		
Three-phase								
4SR1/13 - PD	1 1/4"	98	400	304	704	13.7		
4SR1/18 - PD			517	304	821	14.4		
4SR1/25 - PD			646	329	975	17.1		
4SR1/35 - PD			856	354	1210	19.9		
4SR1/45 - PD			1065	428	1493	23.0		
4SR1.5/8 - PD			308	304	612	10.8		
4SR1.5/13 - PD			400	304	704	11.7		
4SR1.5/17 - PD			499	329	828	14.3		
4SR1.5/25 - PD			646	354	1000	17.8		
4SR1.5/32 - PD			800	428	1228	24.3		
4SR1.5/46 - PD			1134	467	1601	27.7		
4SR2/7 - PD			290	304	594	10.5		
4SR2/10 - PD			345	304	649	11.3		
4SR2/13 - PD			400	329	729	13.3		
4SR2/20 - PD			554	354	908	16.7		
4SR2/27 - PD			683	428	1111	19.9		
4SR2/39 - PD			929	467	1396	25.0		
4SR4/7 - PD			314	304	618	12.2		
4SR4/9 - PD			358	329	687	12.5		
4SR4/14 - PD			468	354	822	15.8		
4SR4/18 - PD			580	428	1008	17.6		
4SR4/26 - PD			756	467	1223	21.4		
4SR4/35 - PD			978	522	1500	26.1		
4SR4/46 - PD			1295	587	1882	34.3		
4SR4/60 - PD			1652	687	2339	45.1		
4SR6/4 - PD			2"	98	281	304	585	10.8
4SR6/6 - PD					341	329	670	13.1
4SR6/9 - PD					431	354	785	14.9
4SR6/13 - PD					576	428	1004	17.2
4SR6/17 - PD					695	467	1162	20.3
4SR6/23 - PD					900	522	1422	24.6
4SR6/31 - PD					1164	587	1751	32.0
4SR6/42 - PD	1519	687			2206	40.7		
4SR6/56 - PD	2063	768			2831	51.7		
4SR8/4 - PD	281	329			610	12.6		
4SR8/7 - PD	371	354			725	13.7		
4SR8/9 - PD	431	428			859	16.0		
4SR8/13 - PD	576	467			1043	19.2		
4SR8/17 - PD	695	522			1217	24.0		
4SR8/23 - PD	900	587			1487	27.6		
4SR8/31 - PD	1164	687			1851	36.6		
4SR8/42 - PD	1519	768	2287	44.6				
4SR10/5 - PD	416	354	770	15.3				
4SR10/7 - PD	518	428	946	16.9				
4SR10/10 - PD	709	467	1176	21.4				
4SR10/15 - PD	1001	522	1523	25.6				
4SR10/20 - PD	1256	587	1843	33.4				
4SR10/26 - PD	1599	687	2286	41.4				
4SR10/35 - PD	2095	768	2863	49.4				
4SR12/4 - PD	365	354	719	13.5				
4SR12/6 - PD	467	428	895	17.7				
4SR12/9 - PD	658	467	1125	21.1				
4SR12/12 - PD	810	522	1332	24.4				
4SR12/16 - PD	1052	587	1639	28.9				
4SR12/22 - PD	1358	687	2045	37.5				
4SR12/29 - PD	1752	768	2520	46.5				
4SR15/5 - PD	421	428	849	16.1				
4SR15/7 - PD	525	467	992	18.8				
4SR15/10 - PD	719	522	1241	24.5				
4SR15/13 - PD	874	587	1461	27.3				
4SR15/18 - PD	1172	687	1859	36.3				
4SR15/24 - PD	1521	768	2289	43.7				



MODEL	PORT DN	DIMENSIONS mm			kg			
		Ø	h1	h2		h		
Single-phase								
4SR1m/13 - FK	1 1/4"	98	400	242	642	13.0		
4SR1m/18 - FK			517	271	788	15.4		
4SR1m/25 - FK			646	298	944	18.6		
4SR1m/35 - FK			856	327	1183	21.8		
4SR1m/45 - FK			1065	356	1421	25.4		
4SR1.5m/8 - FK			308	242	550	12.6		
4SR1.5m/13 - FK			400	271	671	14.9		
4SR1.5m/17 - FK			499	298	797	16.9		
4SR1.5m/25 - FK			646	327	973	19.9		
4SR1.5m/32 - FK			800	356	1156	22.8		
4SR1.5m/46 - FK			1134	460	1594	31.7		
4SR2m/7 - FK			290	242	532	11.6		
4SR2m/10 - FK			345	271	616	13.5		
4SR2m/13 - FK			400	298	698	15.3		
4SR2m/20 - FK			554	327	881	18.0		
4SR2m/27 - FK			683	356	1039	21.1		
4SR2m/39 - FK			929	460	1389	28.1		
4SR4m/7 - FK			2"	98	314	271	585	13.1
4SR4m/9 - FK					358	298	656	14.7
4SR4m/14 - FK					468	327	795	17.1
4SR4m/18 - FK	580	356			936	20.5		
4SR4m/26 - FK	756	460			1216	25.7		
4SR6m/4 - FK	281	271			552	13.8		
4SR6m/6 - FK	341	298			639	14.6		
4SR6m/9 - FK	431	327			758	16.6		
4SR6m/13 - FK	576	356			932	19.4		
4SR6m/17 - FK	695	460			1155	25.8		
4SR8m/4 - FK	281	298			579	14.1		
4SR8m/7 - FK	371	327			698	16.1		
4SR8m/9 - FK	431	356			787	16.6		
4SR8m/13 - FK	576	460			1036	24.5		
4SR10m/5 - FK	416	327			743	17.0		
4SR10m/7 - FK	518	356			874	19.3		
4SR10m/10 - FK	709	460			1169	25.4		
4SR12m/4 - FK	365	327			692	16.6		
4SR12m/6 - FK	467	356			823	18.8		
4SR12m/9 - FK	658	460			1118	25.2		
4SR15m/5 - FK	421	356	777	18.5				
4SR15m/7 - FK	525	460	985	23.8				

MODEL	PORT DN	DIMENSIONS mm			kg			
		Ø	h1	h2		h		
Three-phase								
4SR1/13 - FK	1 1/4"	98	400	223	623	13.2		
4SR1/18 - FK			517	242	759	14.7		
4SR1/25 - FK			646	271	917	17.2		
4SR1/35 - FK			856	298	1154	20.7		
4SR1/45 - FK			1065	327	1392	24.0		
4SR1.5/8 - FK			308	223	531	11.6		
4SR1.5/13 - FK			400	242	642	13.6		
4SR1.5/17 - FK			499	271	770	16.9		
4SR1.5/25 - FK			646	298	944	18.3		
4SR1.5/32 - FK			800	327	1127	21.8		
4SR1.5/46 - FK			1134	356	1490	27.2		
4SR2/7 - FK			290	223	513	10.8		
4SR2/10 - FK			345	242	587	11.8		
4SR2/13 - FK			400	271	671	13.5		
4SR2/20 - FK			554	298	852	16.3		
4SR2/27 - FK			683	327	1010	20.4		
4SR2/39 - FK			929	356	1285	24.1		
4SR4/7 - FK			314	242	556	11.4		
4SR4/9 - FK			358	271	629	13.5		
4SR4/14 - FK			468	298	766	15.4		
4SR4/18 - FK			580	327	907	17.3		
4SR4/26 - FK			756	356	1112	20.4		
4SR4/35 - FK			978	423	1401	26.5		
4SR4/46 - FK			1295	583	1878	39.6		
4SR4/60 - FK			1652	698	2350	49.3		
4SR6/4 - FK			2"	98	281	242	523	12.5
4SR6/6 - FK					341	271	612	12.8
4SR6/9 - FK					431	298	729	14.9
4SR6/13 - FK					576	327	903	18.2
4SR6/17 - FK					695	356	1051	20.2
4SR6/23 - FK					900	423	1323	24.5
4SR6/31 - FK					1164	583	1747	36.4
4SR6/42 - FK					1519	698	2217	44.9
4SR6/56 - FK					2063	774	2837	55.5
4SR8/4 - FK					281	271	552	12.3
4SR8/7 - FK					371	298	669	14.4
4SR8/9 - FK					431	327	758	15.9
4SR8/13 - FK					576	356	932	18.5
4SR8/17 - FK					695	423	1118	22.8
4SR8/23 - FK					900	583	1483	33.9
4SR8/31 - FK	1164	698			1862	41.7		
4SR8/42 - FK	1519	774			2293	48.4		
4SR10/5 - FK	416	298			714	15.7		
4SR10/7 - FK	518	327			845	17.9		
4SR10/10 - FK	709	356			1065	20.4		
4SR10/15 - FK	1001	423	1424	26.1				
4SR10/20 - FK	1256	583	1839	36.6				
4SR10/26 - FK	1599	698	2297	45.0				
4SR10/35 - FK	2095	774	2869	53.2				
4SR12/4 - FK	365	298	663	15.3				
4SR12/6 - FK	467	327	794	17.4				
4SR12/9 - FK	658	356	1014	20.6				
4SR12/12 - FK	810	423	1233	26.2				
4SR12/16 - FK	1052	583	1635	34.2				
4SR12/22 - FK	1358	698	2056	42.7				
4SR12/29 - FK	1752	774	2526	48.4				
4SR15/5 - FK	421	327	748	17.1				
4SR15/7 - FK	525	356	881	19.3				
4SR15/10 - FK	719	423	1142	23.5				
4SR15/13 - FK	874	583	1457	33.0				
4SR15/18 - FK	1172	698	1870	41.0				
4SR15/24 - FK	1521	774	2295	47.5				

DIMENSIONS AND WEIGHT (PUMP ONLY)

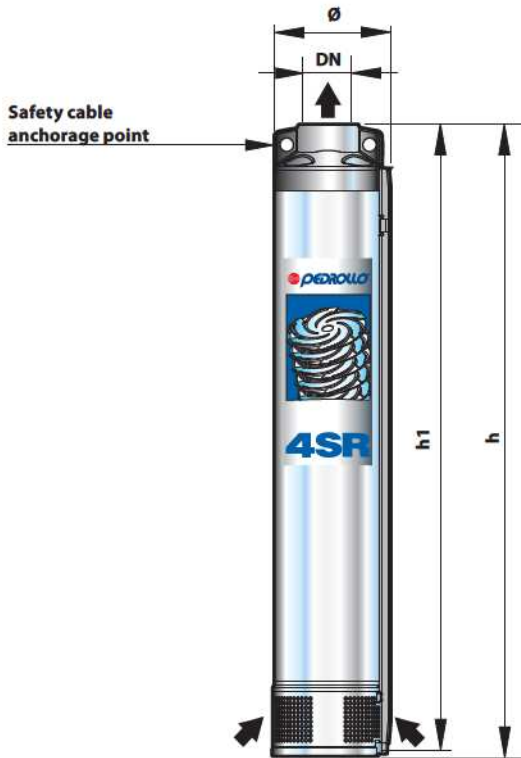

MODEL	PORT	DIMENSIONS mm			kg
		Ø	h1	h	
Pump	DN				
4SR1/13 - HYD	1 1/4"	98	400	403	4.7
4SR1/18 - HYD			517	520	5.9
4SR1/25 - HYD			646	649	7.4
4SR1/35 - HYD			856	859	9.4
4SR1/45 - HYD			1065	1068	11.4
4SR1.5/8 - HYD			308	311	3.8
4SR1.5/13 - HYD			400	403	4.8
4SR1.5/17 - HYD			499	502	5.7
4SR1.5/25 - HYD			646	649	7.3
4SR1.5/32 - HYD			800	803	9.2
4SR1.5/46 - HYD			1134	1137	13.2
4SR2/7 - HYD			290	293	3.6
4SR2/10 - HYD			345	348	4.2
4SR2/13 - HYD			400	403	4.8
4SR2/20 - HYD			554	557	7.0
4SR2/27 - HYD			683	686	7.7
4SR2/39 - HYD			929	932	10.5
4SR4/7 - HYD			314	317	3.8
4SR4/9 - HYD			358	361	4.3
4SR4/14 - HYD			468	471	5.4
4SR4/18 - HYD	580	583	6.6		
4SR4/26 - HYD	756	759	8.3		
4SR4/35 - HYD	978	981	10.7		
4SR4/46 - HYD	1295	1298	15.0		
4SR4/60 - HYD	1652	1655	19.4		
4SR6/4 - HYD	2"	98	281	284	3.7
4SR6/6 - HYD			341	344	4.0
4SR6/9 - HYD			431	434	4.8
4SR6/13 - HYD			576	579	6.1
4SR6/17 - HYD			695	698	7.1
4SR6/23 - HYD			900	903	9.3
4SR6/31 - HYD			1164	1167	11.8
4SR6/42 - HYD			1519	1522	15.0
4SR6/56 - HYD			2063	2066	22.0
4SR8/4 - HYD			281	284	3.5
4SR8/7 - HYD			371	374	4.2
4SR8/9 - HYD			431	434	4.7
4SR8/13 - HYD			576	579	6.1
4SR8/17 - HYD			695	698	7.2
4SR8/23 - HYD			900	903	9.3
4SR8/31 - HYD			1164	1167	11.8
4SR8/42 - HYD	1519	1522	14.9		
4SR10/5 - HYD	416	419	4.4		
4SR10/7 - HYD	518	521	5.3		
4SR10/10 - HYD	709	712	6.9		
4SR10/15 - HYD	1001	1004	9.5		
4SR10/20 - HYD	1256	1259	12.0		
4SR10/26 - HYD	1599	1602	15.7		
4SR10/35 - HYD	2095	2098	19.7		
4SR12/4 - HYD	365	368	4.0		
4SR12/6 - HYD	467	470	4.8		
4SR12/9 - HYD	658	661	6.6		
4SR12/12 - HYD	810	813	8.1		
4SR12/16 - HYD	1052	1055	9.6		
4SR12/22 - HYD	1358	1361	12.8		
4SR12/29 - HYD	1752	1755	15.9		
4SR15/5 - HYD	421	424	4.5		
4SR15/7 - HYD	525	528	5.3		
4SR15/10 - HYD	719	722	7.0		
4SR15/13 - HYD	874	877	8.4		
4SR15/18 - HYD	1172	1175	11.1		
4SR15/24 - HYD	1521	1524	14.0		

INSTALLATION EXAMPLE

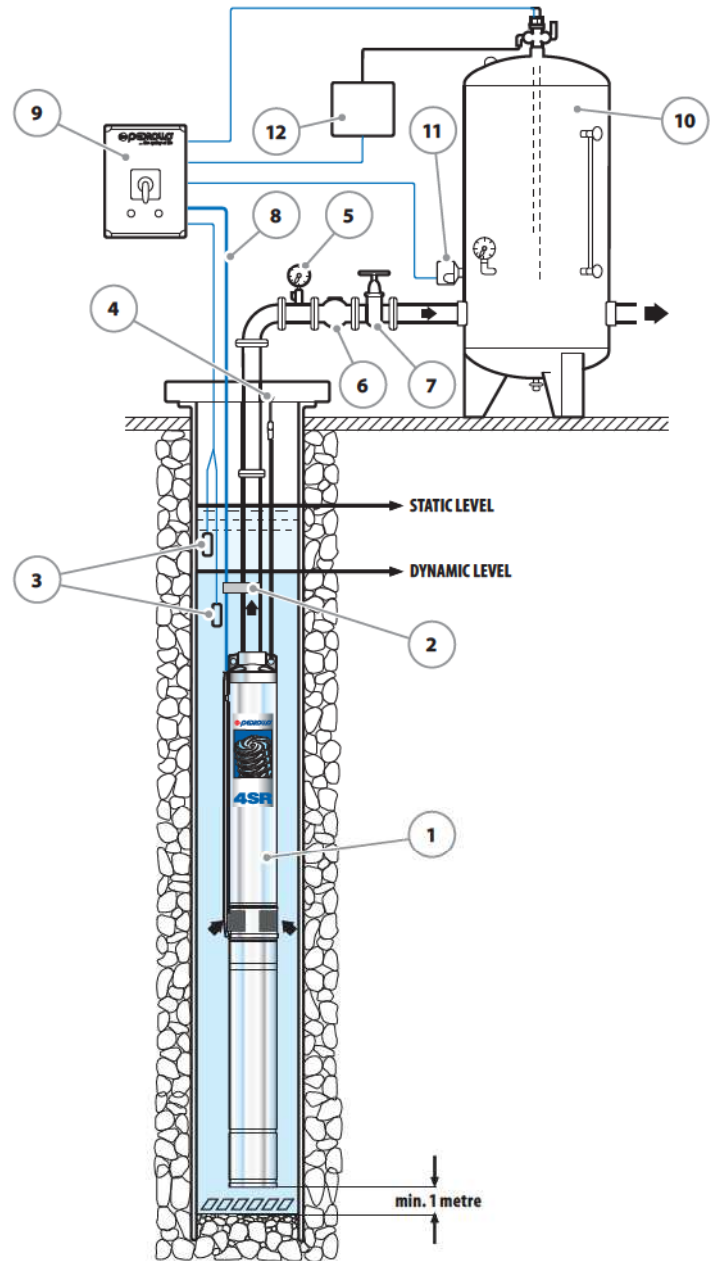
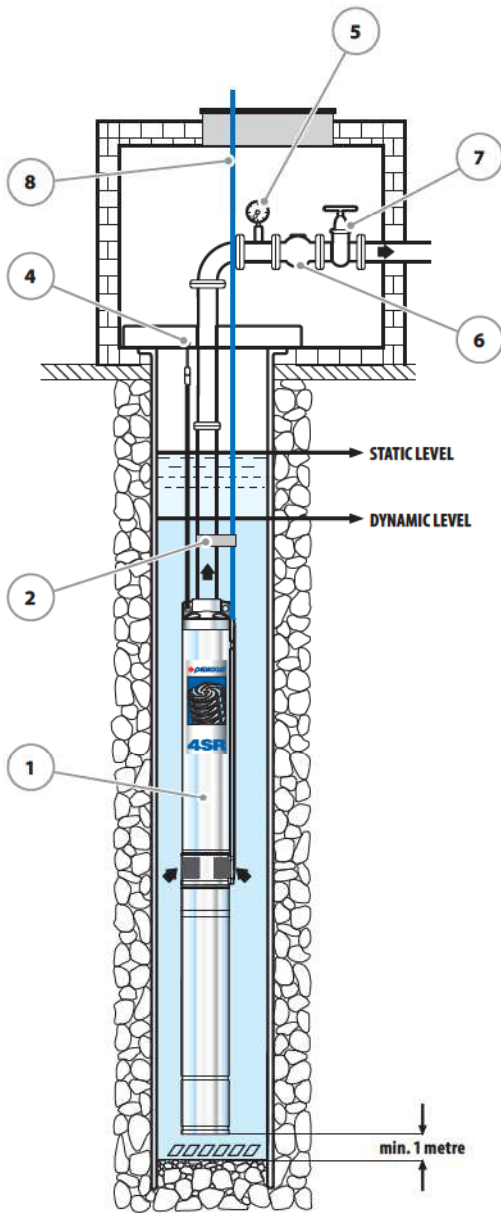

COMPONENTS

- | | |
|--|--|
| <ul style="list-style-type: none"> 1) Submersible pump 2) Power cable clamps 3) Level probes; prevent dry running 4) Pump anchorage 5) Pressure gauge 6) Non-return valve 7) Gate valve; for flow rate regulation | <ul style="list-style-type: none"> 8) Power cable 9) Control box 10) Pressure vessel 11) Pressure switch 12) Electro valve/electro-compressor |
|--|--|

➔ The 4SR series pumps should be installed in boreholes of at least 4" (100 mm) in diameter. The pump should be lowered into the borehole, by means of the delivery pipe, to such a depth (min. 50 cm and at least one metre from the bottom) that it is completely immersed during operation when the level of water in the borehole may reduce. It is good practice to secure the pump by attaching a stainless steel cable to the anchorage points present on the delivery body.